

Chassis-Masse erfassen
Determine Chassis Dimensions

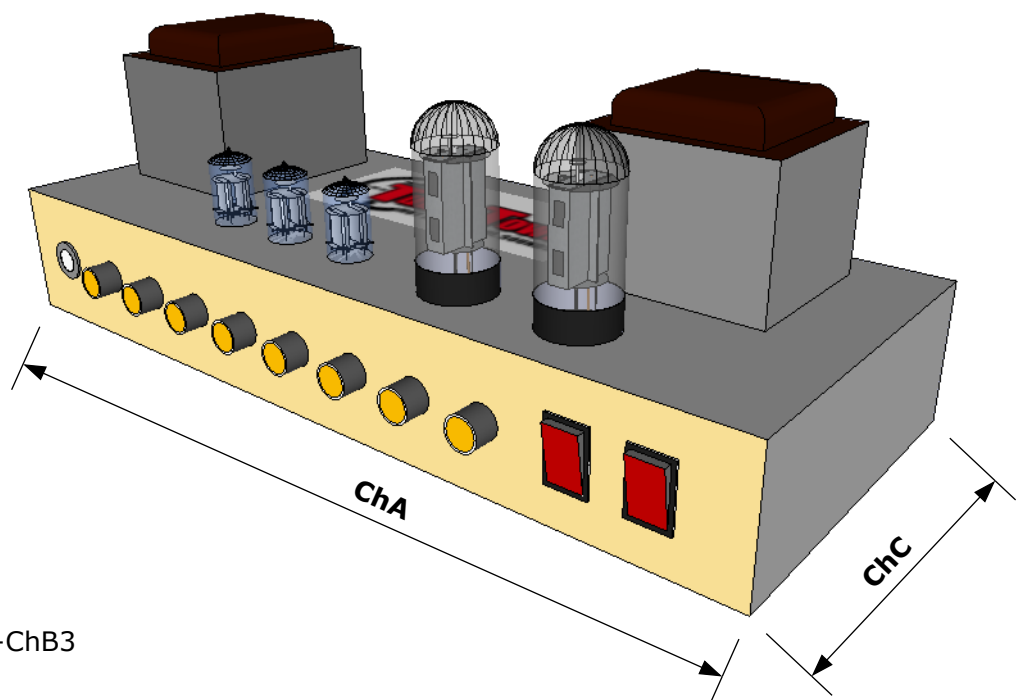
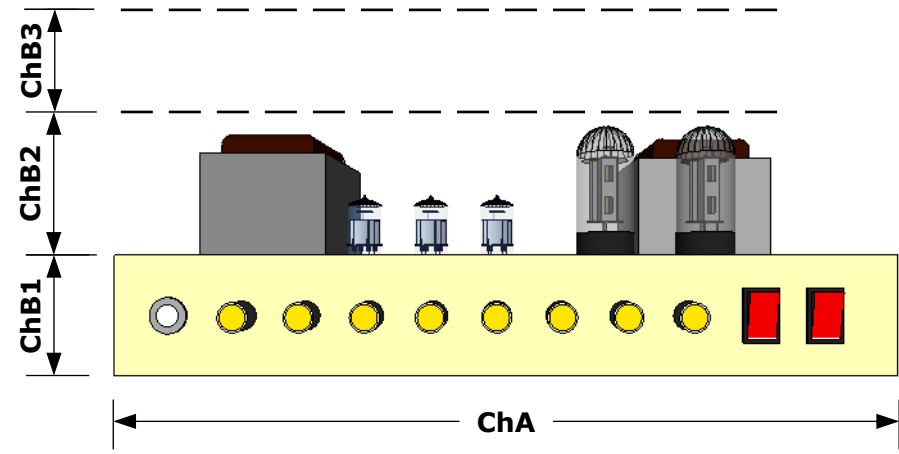
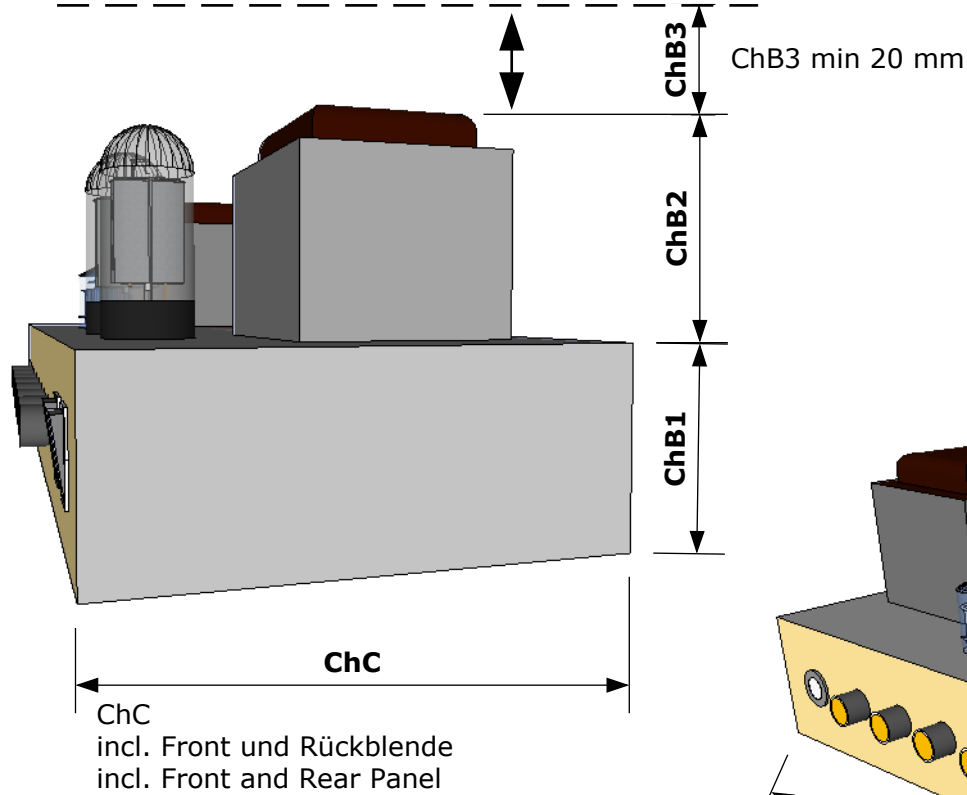

Chassis Grösse / Size

ChA:	mm
ChB1:	mm
ChB2:	mm
ChB3:	mm
ChB:	mm
ChC:	mm

$ChB = ChB1 + ChB2 + ChB3$



TTC Customshop Headshell
 Britisch #10

Gehäuse Berechnung
Enclosure Calculation

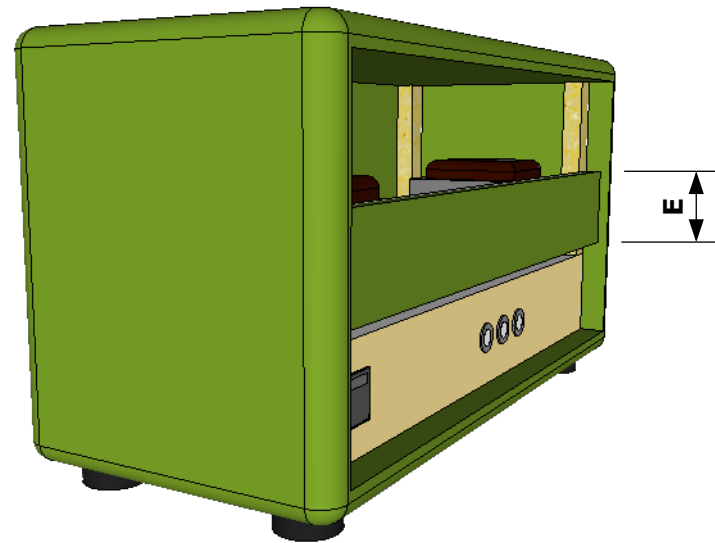
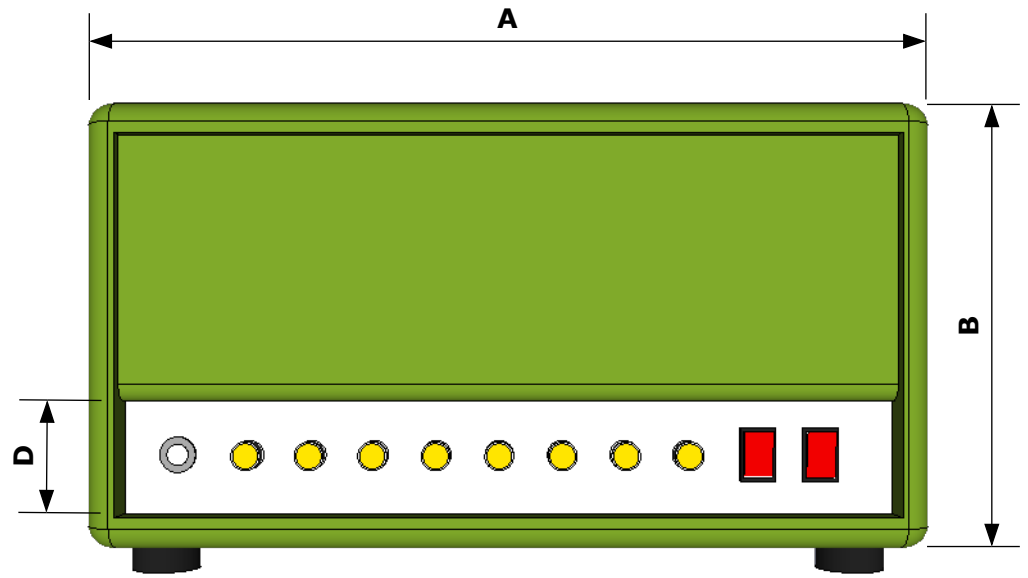
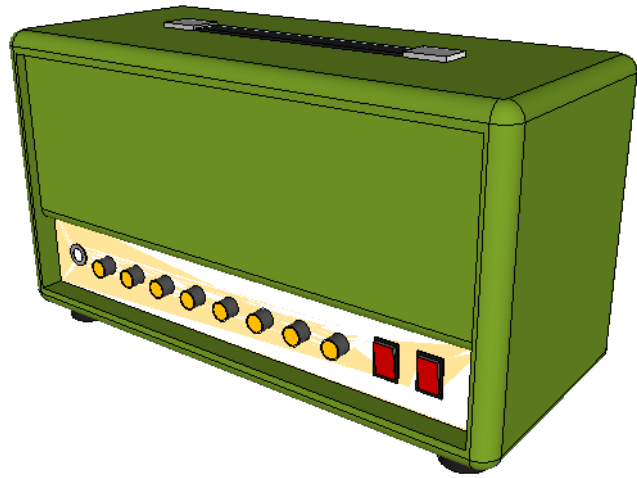

TTC Customshop Headshell
Britisch #10

Gehäuse Berechnung
Enclosure Calculation

Chassis Grösse / Size

A = ChA + 33 mm:		mm
B = ChB + 30 mm:		mm
C = ChC + 48 mm:		mm
D = ChB1 - 3 mm:		mm
E:		mm

Material:

Korpus / Body: 15 mm Birke Multiplex / 15 mm Birch Plywood
 Frontplende / Frontpanel: 15 mm Birke Multiplex / 15 mm Birch Plywood
 Rückblende / Backpanel: 15 mm Birke Multiplex / 15 mm Birch Plywood

All illustrations are not to scale !
 Please see product-descriptions for details and features.
 Due to continual improvement, all specifications are subject to change without notice.

Alle Darstellungen sind nicht masstabgetreu !
 Weitere Details und Ausstattungsmerkmale sind der Produktbeschreibung zu entnehmen.
 Durch permanente Weiterentwicklung können Änderungen ohne Vorankündigung durchgeführt werden.

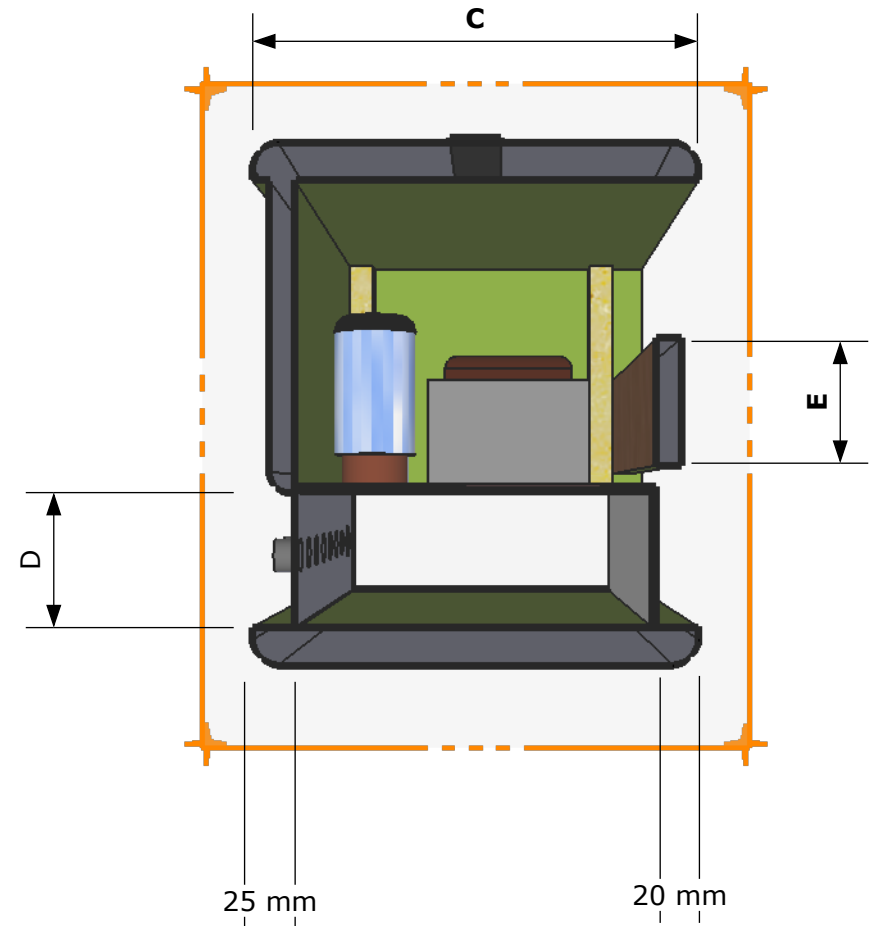

TTC Customshop Headshell
 Britisch #10