

**Chassis-Masse erfassen**  
**Determine Chassis Dimensions**

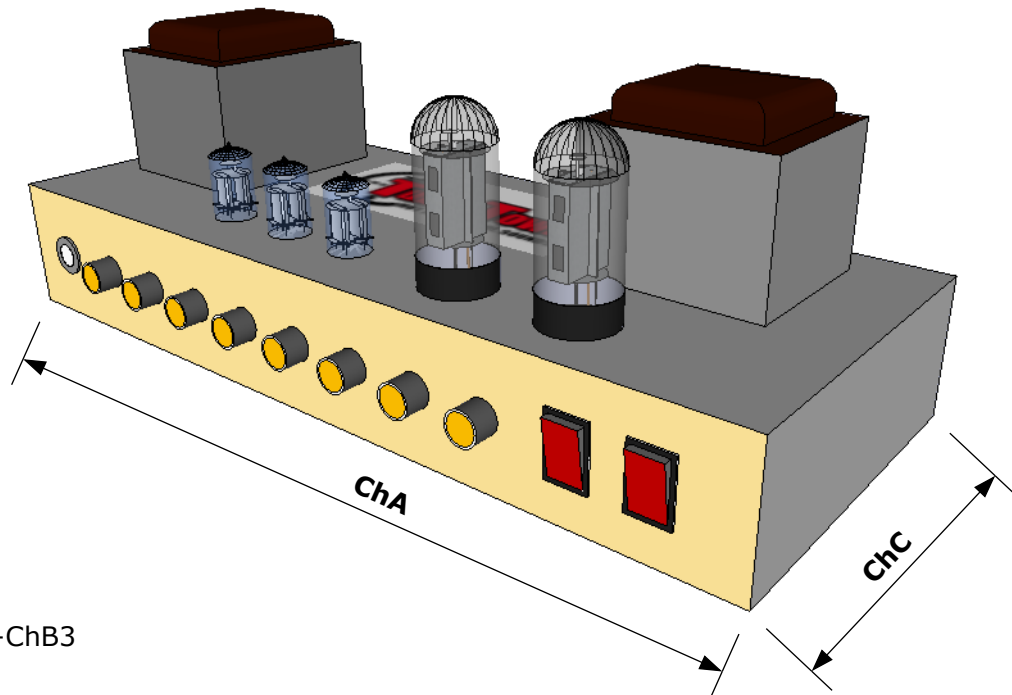
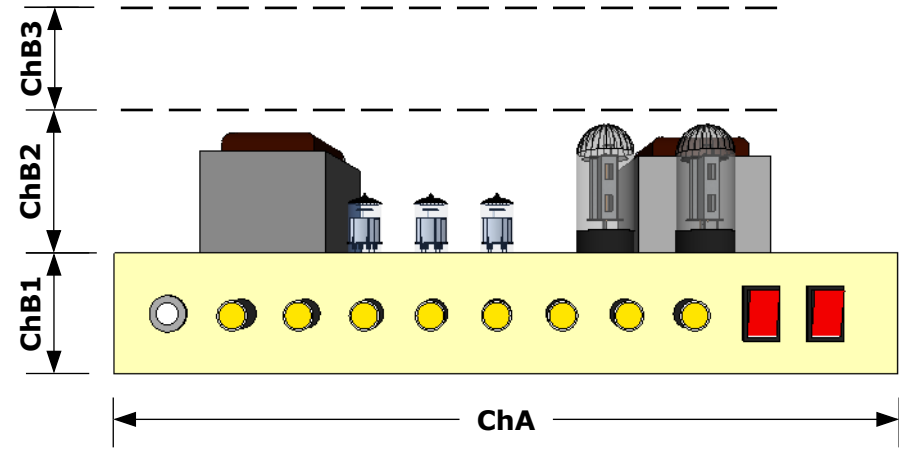
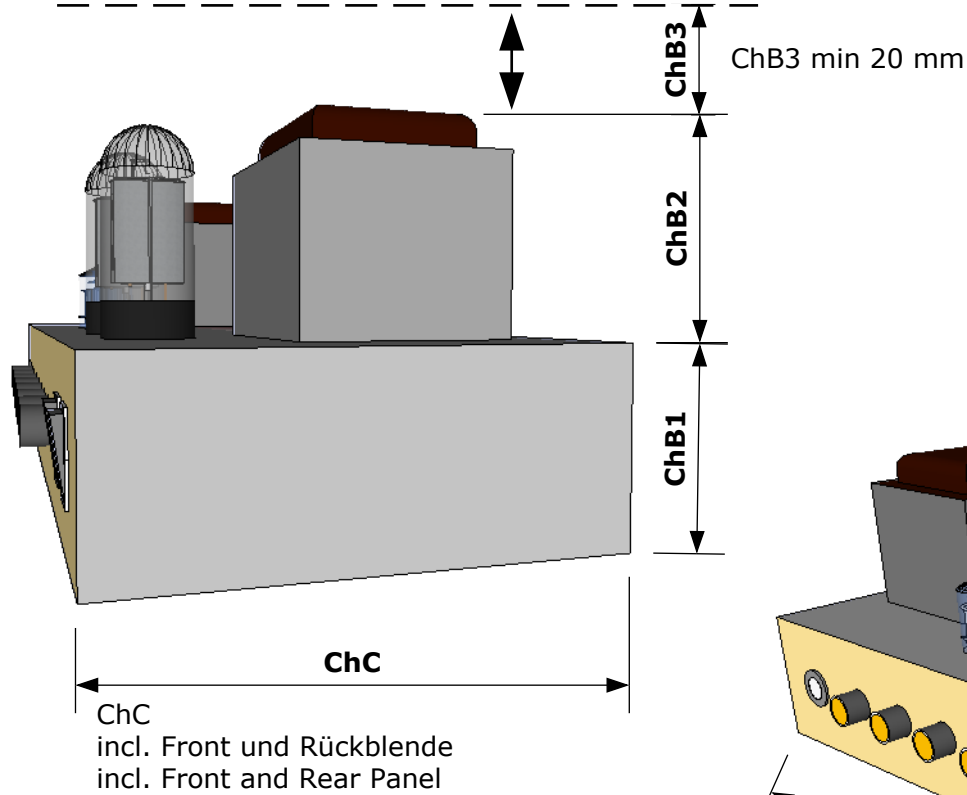

**Chassis Grösse / Size**

ChA:	mm
ChB1:	mm
ChB2:	mm
ChB3:	mm
ChB:	mm
ChC:	mm

$ChB = ChB1 + ChB2 + ChB3$



TTC Customshop Headshell  
 Britisch #20

**Gehäuse Berechnung**  
**Enclosure Calculation**

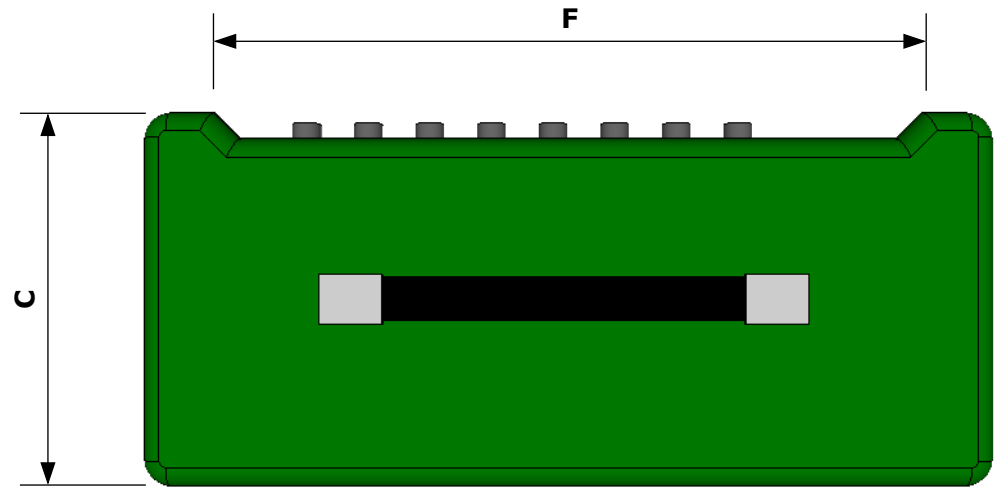
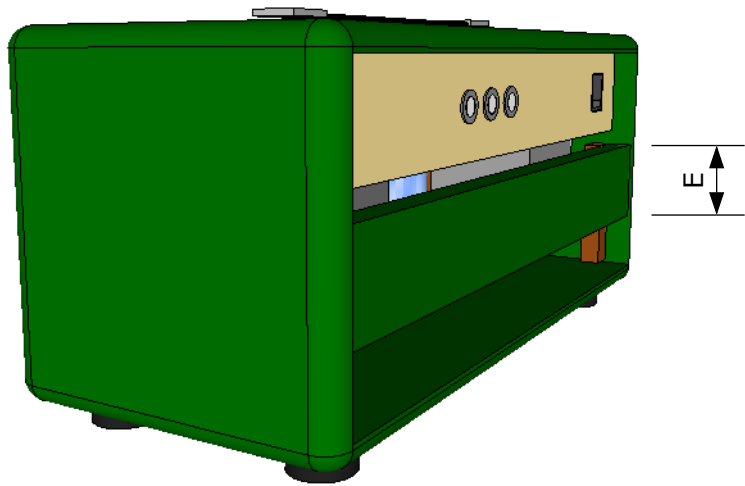
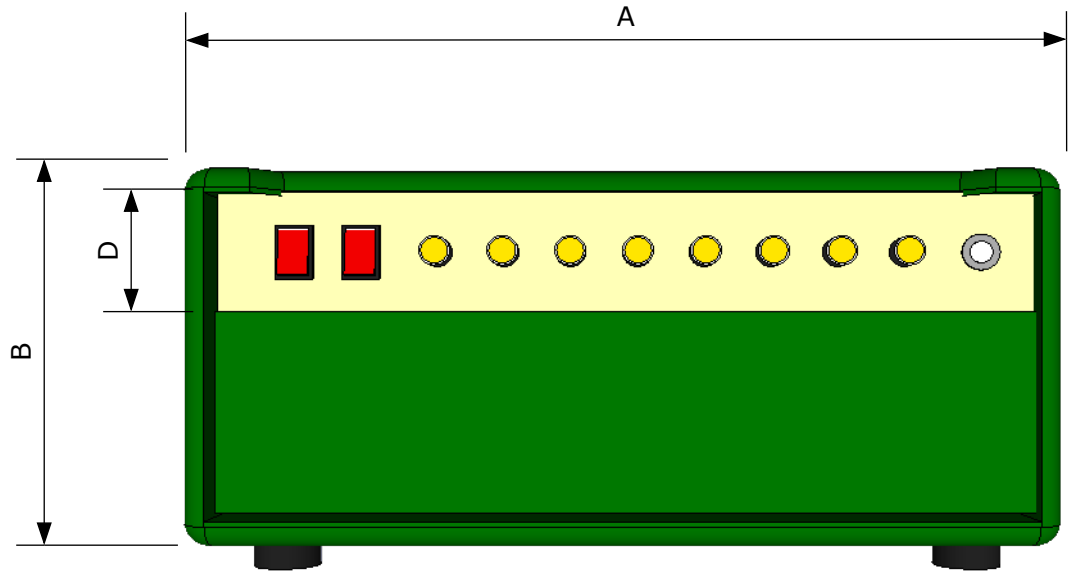
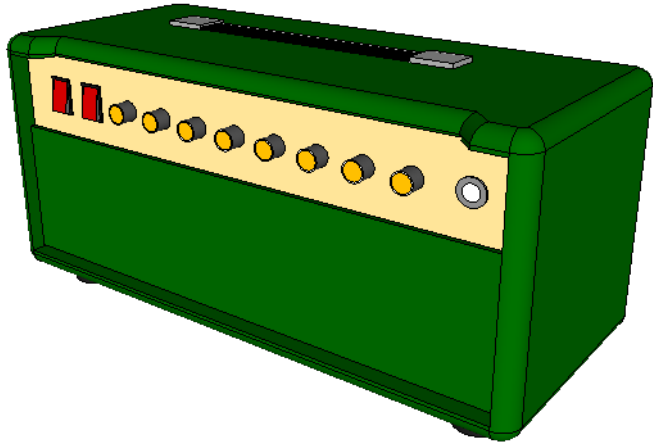

TTC Customshop Headshell  
Britisch #20

**Gehäuse Berechnung**  
**Enclosure Calculation**

**Chassis Grösse / Size**

A = ChA + 33 mm:		mm
B = ChB + 30 mm:		mm
C = ChC + 40 mm:		mm
D = ChB1 + 2 mm:		mm
E:		mm
F = A - 60 mm :		mm

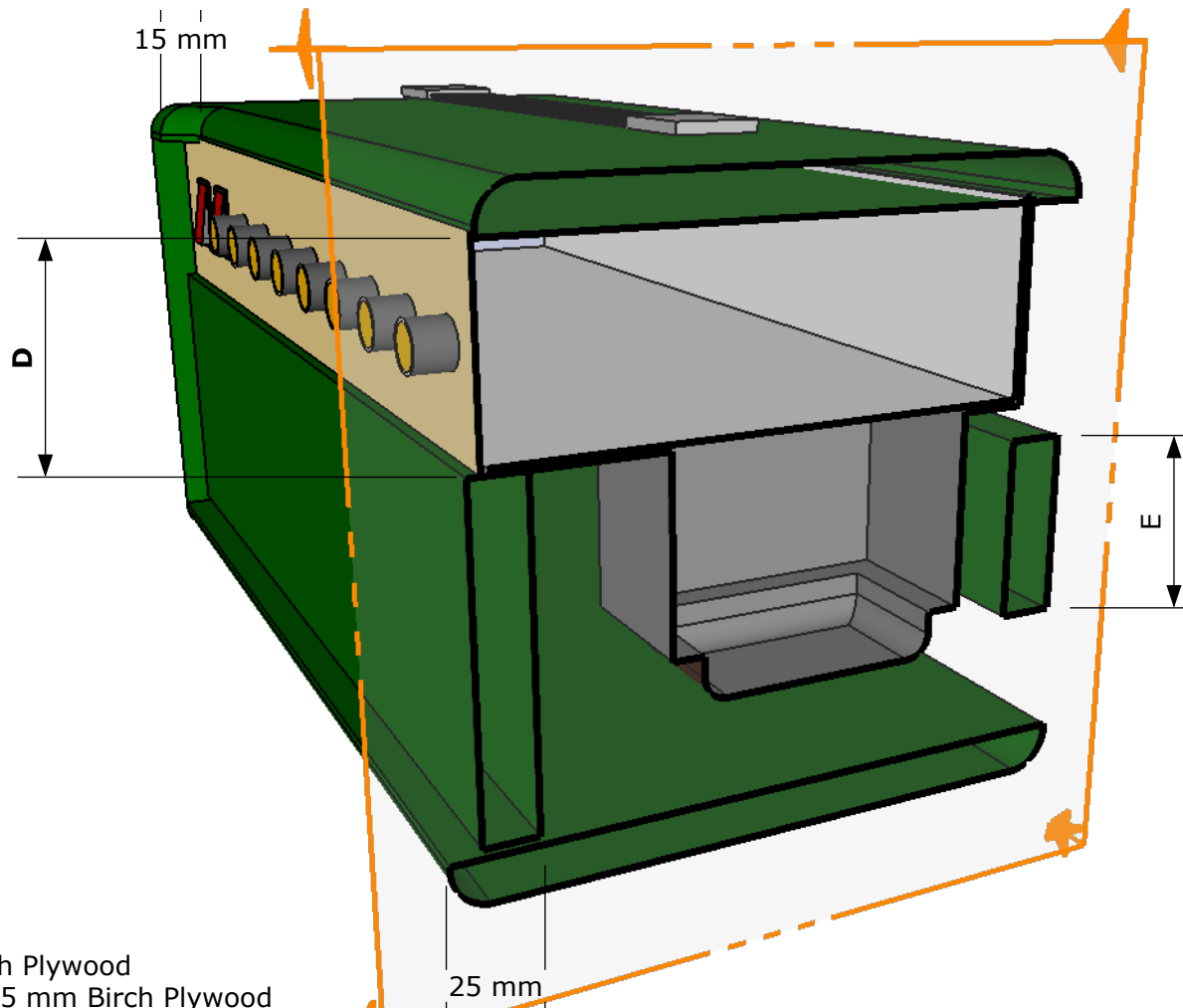

**Material:**

Korpus / Body: 15 mm Birke Multiplex / 15 mm Birch Plywood  
 Frontplende / Frontpanel: 15 mm Birke Multiplex / 15 mm Birch Plywood  
 Rückblende / Backpanel: 15 mm Birke Multiplex / 15 mm Birch Plywood

Alle Darstellungen sind nicht massstabsgetreu ! Weitere Details und Ausstattungsmerkmale sind der Produktbeschreibung zu entnehmen.  
 Durch permanente Weiterentwicklung können Änderungen ohne Vorankündigung durchgeführt werden.

-----  
 All illustrations are not to scale ! Please see product-descriptions for details and features.  
 Due to continual improvement, all specifications are subject to change without notice.



TTC Customshop Headshell  
 Britisch #20