

Chassis-Masse erfassen
Determine Chassis Dimensions

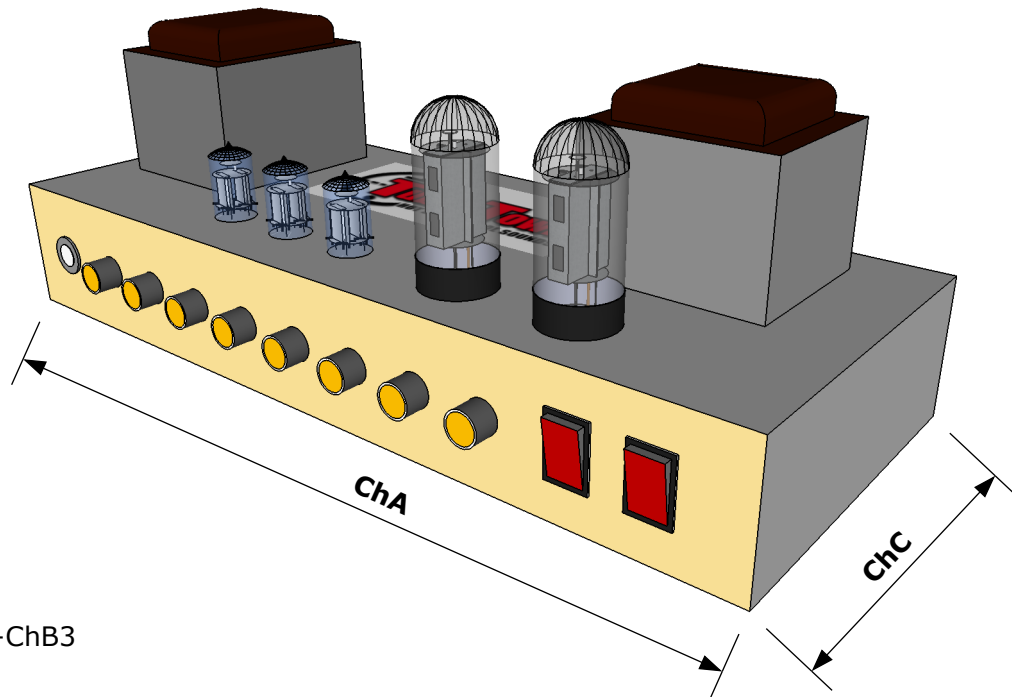
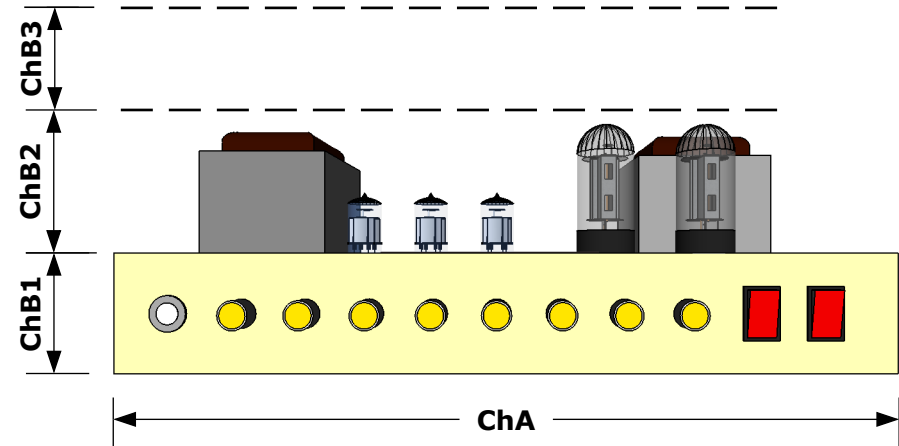
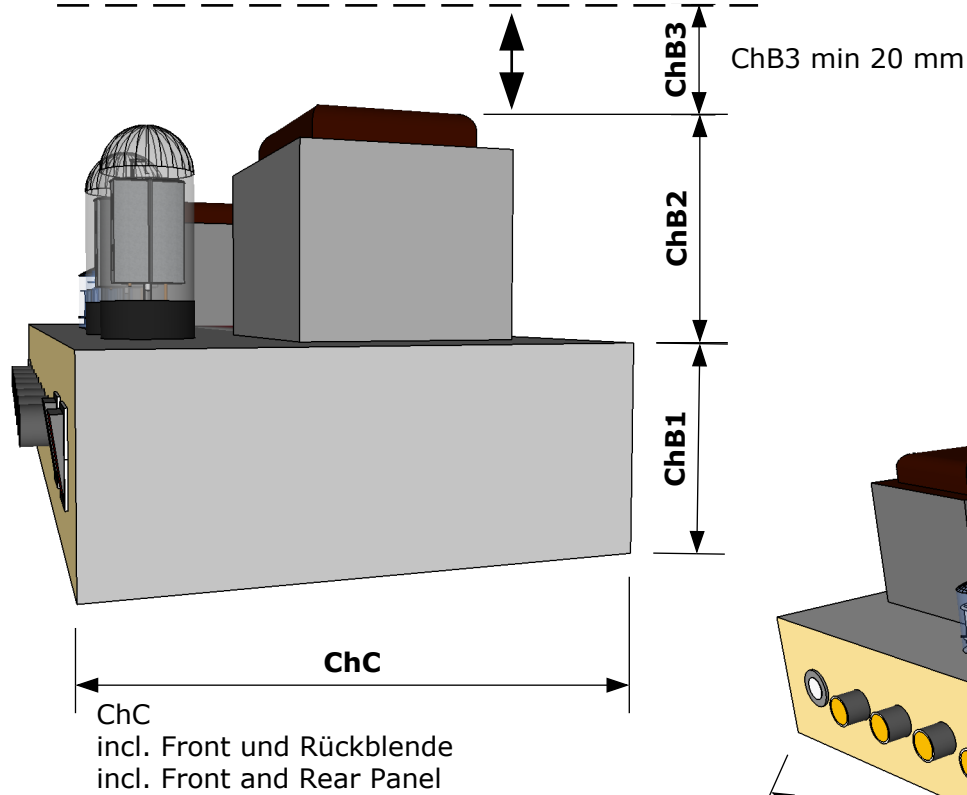

Chassis Grösse / Size

ChA:	mm
ChB1:	mm
ChB2:	mm
ChB3:	mm
ChB:	mm
ChC:	mm

$ChB = ChB1 + ChB2 + ChB3$



TTC Customshop Headshell
 Britisch #25
 Rev 1

Gehäuse Berechnung
Enclosure Calculation

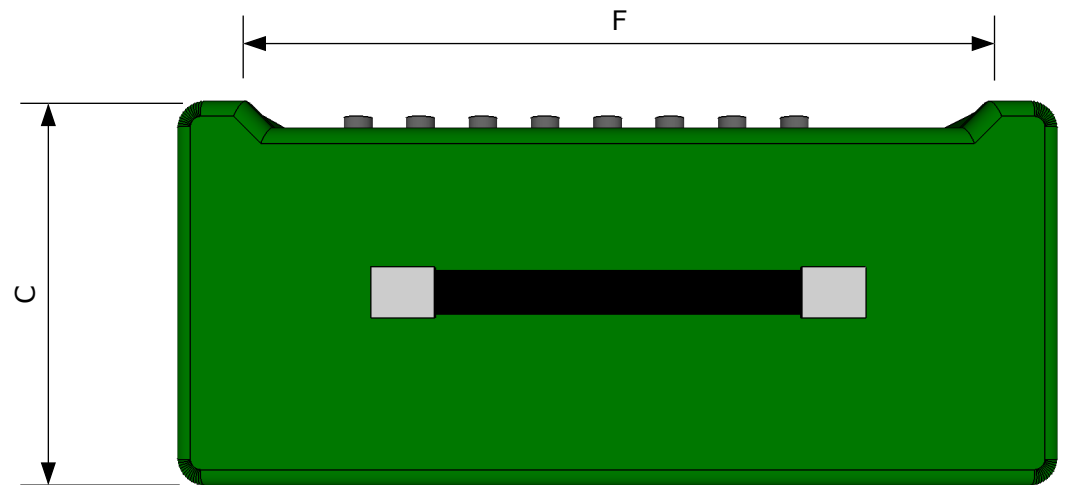
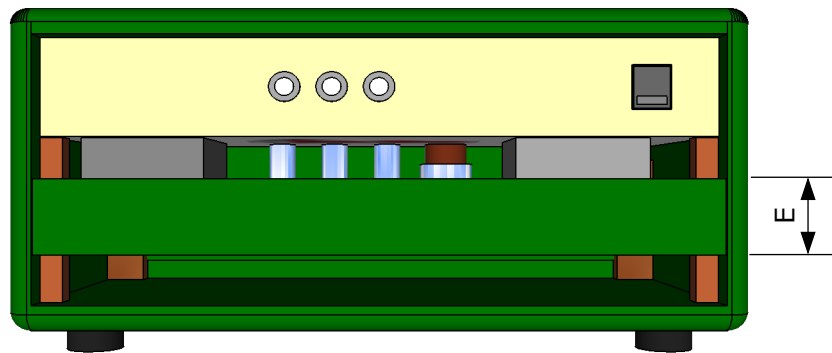
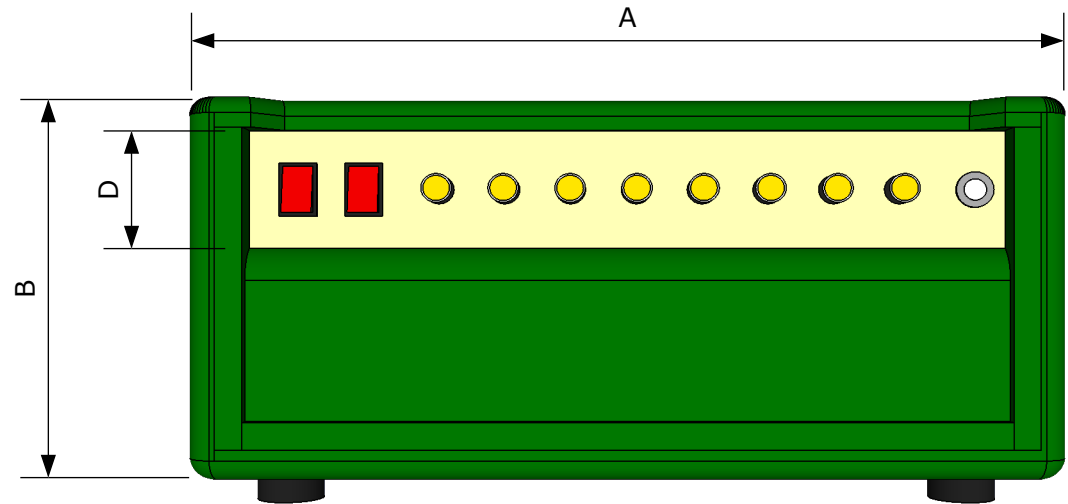
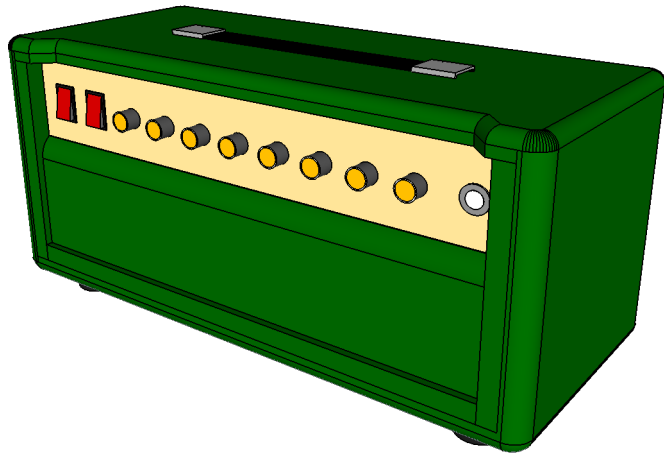

TTC Customshop Headshell
Britisch #25
Rev 1

Gehäuse Berechnung
Enclosure Calculation

Chassis Grösse / Size

A = ChA + 50 mm:		mm
B = ChB + 30 mm:		mm
C = ChC + 40 mm:		mm
D = ChB1 - 3 mm:		mm
E =		mm
F = A - 74 mm:		mm

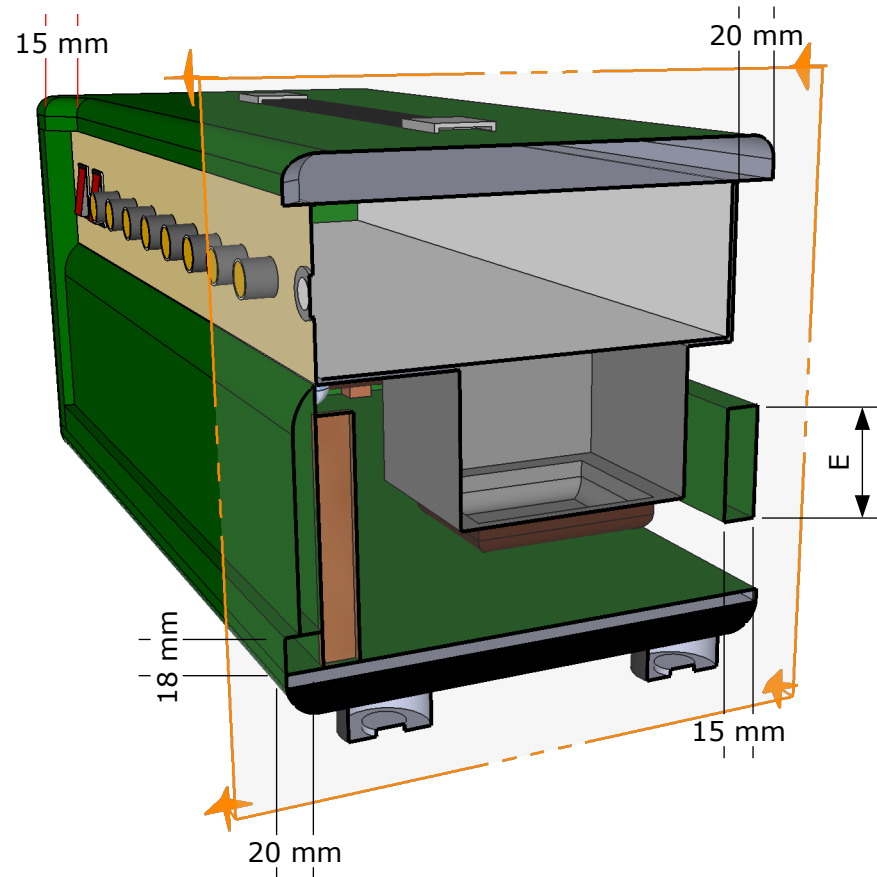

Material:

Korpus / Body: 15 mm Birke Multiplex / 15 mm Birch Plywood
 Frontplende / Frontpanel: 15 mm Birke Multiplex / 15 mm Birch Plywood
 Rückblende / Backpanel: 15 mm Birke Multiplex / 15 mm Birch Plywood

Alle Darstellungen sind nicht massstabsgetreu ! Weitere Details und Ausstattungsmerkmale sind der Produktbeschreibung zu entnehmen.
 Durch permanente Weiterentwicklung können Änderungen ohne Vorankündigung durchgeführt werden.

 All illustrations are not to scale ! Please see product-descriptions for details and features.
 Due to continual improvement, all specifications are subject to change without notice.



TTC Customshop Headshell
 British #25
 Rev 1