

Chassis-Masse erfassen
Determine Chassis Dimensions

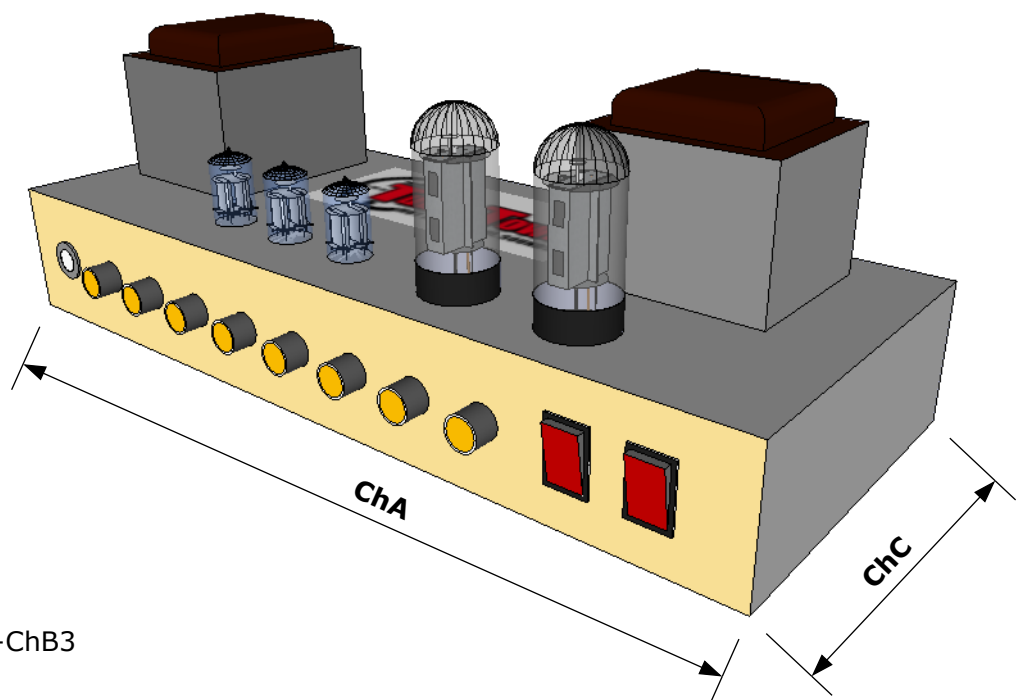
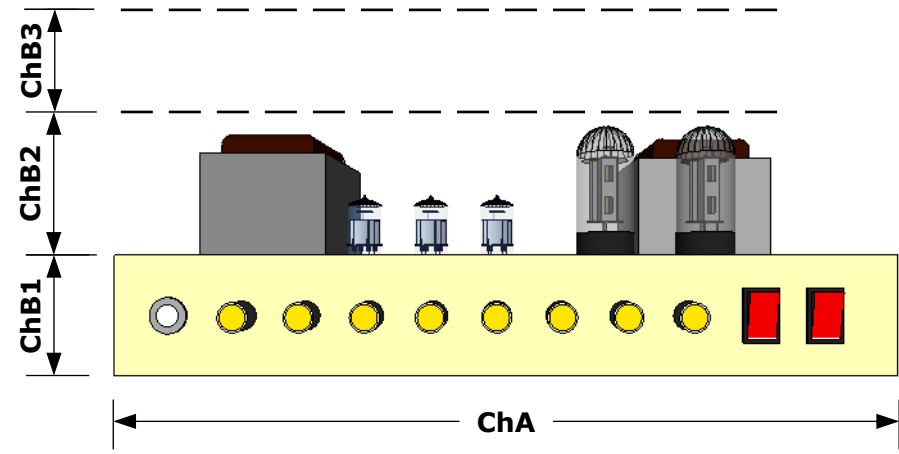
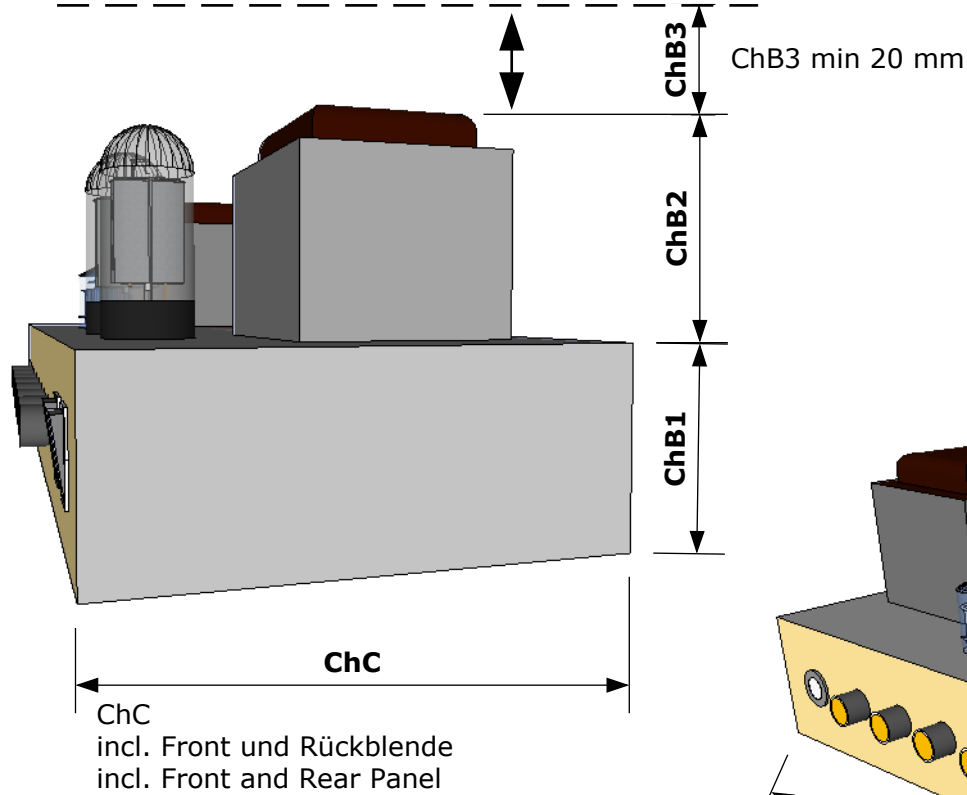

Chassis Grösse / Size

ChA:	mm
ChB1:	mm
ChB2:	mm
ChB3:	mm
ChB:	mm
ChC:	mm

$ChB = ChB1 + ChB2 + ChB3$



TTC Customshop Headshell
 Lemberg #15

Gehäuse Berechnung
Enclosure Calculation

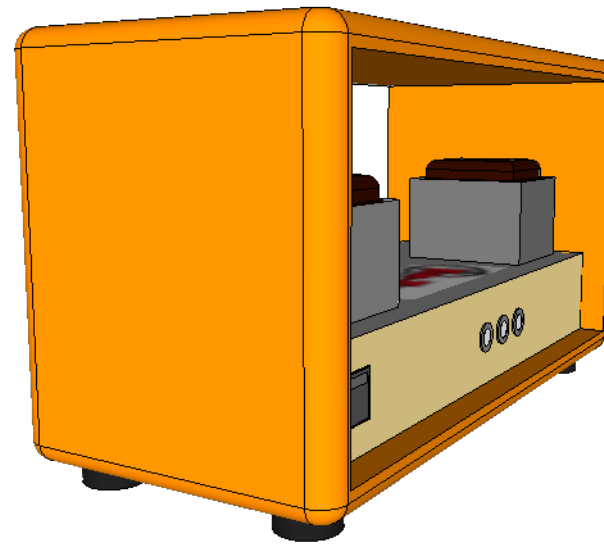
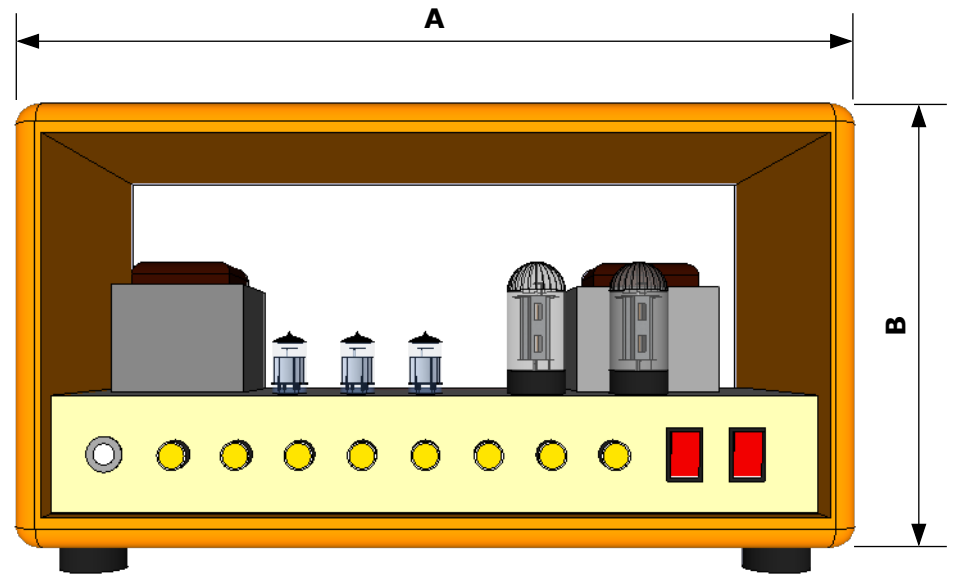
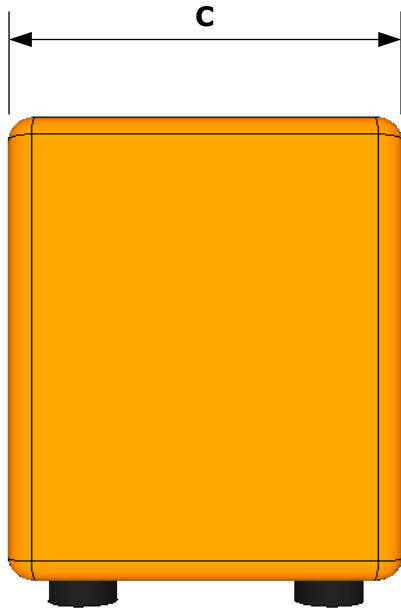
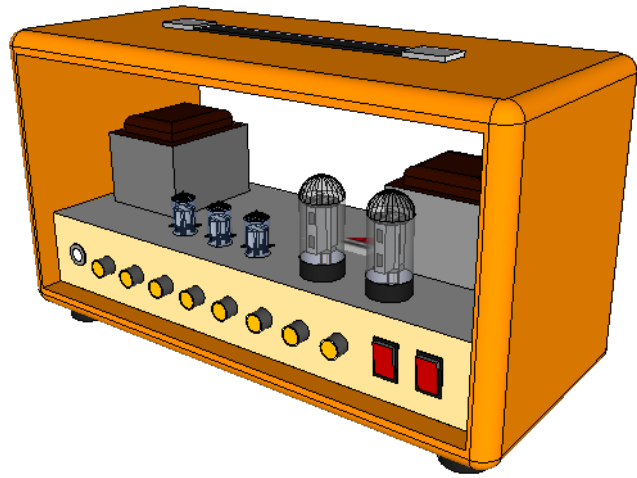

TTC Customshop Headshell
Lemberg #15

Gehäuse Berechnung
Enclosure Calculation

Chassis Größe / Size

A = ChA + 39 mm:		mm
B = ChB + 36 mm:		mm
C = ChC + 48 mm:		mm
		mm
		mm

Material:

Korpus / Body: 18 mm Kiefer Multiplex / 18 mm Pine Plywood
 Frontplatte / Frontpanel: -
 Rückplatte / Backpanel: -

All illustrations are not to scale !
 Please see product-descriptions for details and features.
 Due to continual improvement, all specifications are subject to change without notice.

Alle Darstellungen sind nicht maßstabsgetreu !
 Weitere Details und Ausstattungsmerkmale sind der Produktbeschreibung zu entnehmen.
 Durch permanente Weiterentwicklung können Änderungen ohne Vorankündigung durchgeführt werden.

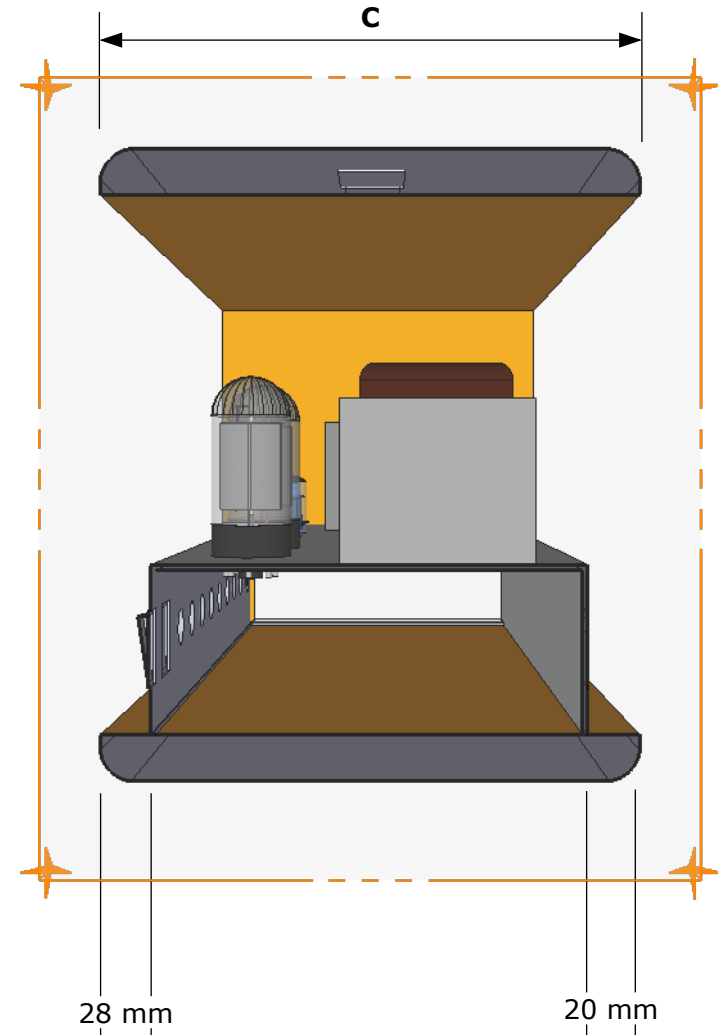

TTC Customshop Headshell
 Lemberg #15